

LTU2000

Leak Detector

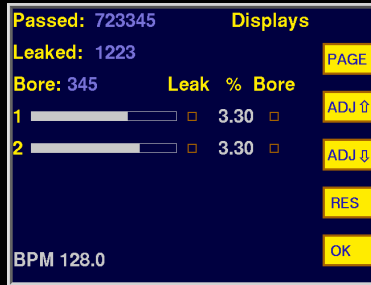

 **PLASTECH**
CONTROL SYSTEMS
www.plastech-controls.com

LTU2000

Trimmer Mount Bottle Leak Detector

User Guide

PLASTECH
CONTROL SYSTEMS



www.plastech-controls.com

Covers Model Numbers

LTU2000

SAFETY WARNING

Electrical machinery contains hazardous voltages. Installation, servicing and adjustment is only to be performed by qualified personnel.

Do not tamper with this device.

Contents

1 Overview	5
<i>•Benefits</i>	
2 Specification	8
<i>•Performance Graphs •Ordering Information</i>	
3 Setting Up	11
4 Operation	14
<i>•Detailed Explanation of Operating Principle</i>	
5 Screens	16
<i>•DISPLAYS Screen •“Detailed Counts” Screen •SETTINGS Screen •Inputs / Outputs Screen</i>	
6 Troubleshooting	22
<i>•Faults Causing Good Bottles to be Rejected •Faults Causing Poor Sensitivity •Faults Causing Blank Display & No Response •Faults Causing Intermittent Valve Operation</i>	
7 Input / Output List	25
8 Electrical Installation	26
<i>•Signals</i>	
9 Firmware Updates	28
10 Battery	29
11 Touch Screen Calibration	31
12 Drawings	32

13 Spares

•*Notes on Spares*

1 Overview

The LTU2000 bottle leak detector is specifically designed for indexed-conveyor deflash trimmers.

It is designed as a plug-compatible replacement for older equipment, specifically as a retrofit package for machines already in the field. It allows consistent, high performance leak testing where existing solutions are aging, unreliable or inaccurate. Customers experience dramatic production efficiency improvements after upgrading, due to the elimination of incorrect bottle rejection and machine down-time.

1.1 Benefits

- Improved Production Efficiency
 - Eliminates incorrect bottle rejection without compromising test accuracy.
- Reliability
 - Interference Immunity
 - 50 million cycle rated valves
 - Output relays use AC/DC solid state switches, suitable for both AC systems and PLCs
 - Self-Diagnostics, self setting capability
- Accuracy
 - High speed 24 bit Analog to Digital converter provides ultimate pressure sensing accuracy and resolution
 - High flow rate pneumatics to quickly achieve bottle pressurization
 - Optimized for short cycle time leak tests
 - Self tuning algorithms to continuously optimize pressurization and threshold settings
 - Adjustable Test Pressure

- Safety
 - No behind-panel access required for machine setting
- Improved Operator Interface
 - Simple, clear graphical color touchscreen
 - Multinational Language Displays available
 - Bargraph display of pressure, led indication of test results for each channel
 - Push Button, Front Panel Settings (changes can be locked out with optional key switch)
 - Correct Number Failed count for all trimmer configurations
 - Panel Mounted Pneumatic Controls
 - Alarm Output Option
- Simple Installation and Maintenance
 - Simplified machine connection - just plugs in to existing connector
 - Simplified Internal Wiring (all electrical functions integrated onto single PCB)
 - Low operating power - reduces load on system supply
 - 110VAC model as standard
 - Valves can be changed without removing pipes - all access from front of control enclosure.
 - Manual override buttons on all valves
 - Single product covers 1 and 2 channel systems
 - LED state indication on valves
- Advanced System Architecture
 - Easy firmware updates to add new features, requires only a standard USB cable
 - Plug-in pressure transducers, allows easy upgrade or replacement
 - Competitive Pricing

For more details contact the office, our distributors or see our web site



Figure 1.1 50 Million Cycle Valves. An LTU2000 installation typically has to do over 10 million cycles per year!



*Lockable Steel
Control Cabinet.
(Internal door
independently locked)*



*1-2 Channels on the
same Circuit Board*

www.plastech-controls.com

where you can obtain complete on-line sales literature, user manuals and technical documentation.

2 Specification

Hole Size Detected	0.1mm (for a 500ml/16oz) bottle and a 2 second test time). See Performance Data for other sizes.
Number of Test Channels	1,2 or 3 (specify when ordering)
Cycle Time	0.5 - 20.0 seconds, adjustable
Minimum Bottle Volume	250ml / 8 oz
Maximum Bottle Volume	25 liters / 6 gallons
Test Pressure	Adjustable, 5-100mB
Power Supply	100-125VAC single phase only
Power Consumption	30 VA maximum
Air Supply	60-150 psi (4-10 bar)
Air Consumption	1 liter per minute typical
Dimensions	Control system enclosure TBAx300x180mm
Leak Test Method	Ratiometric Pressure Decay, Auto-zero, Auto-Scale. Adaptive pressurization algorithm.
Transducer	Semiconductor strain gauge diaphragm, 0.00 - 100.00 mB, 0.000007% resolution, x20 Over-pressure Protection.

2.1 Performance Graphs

These graphs show the hole size detectable for various bottle sizes and test times.

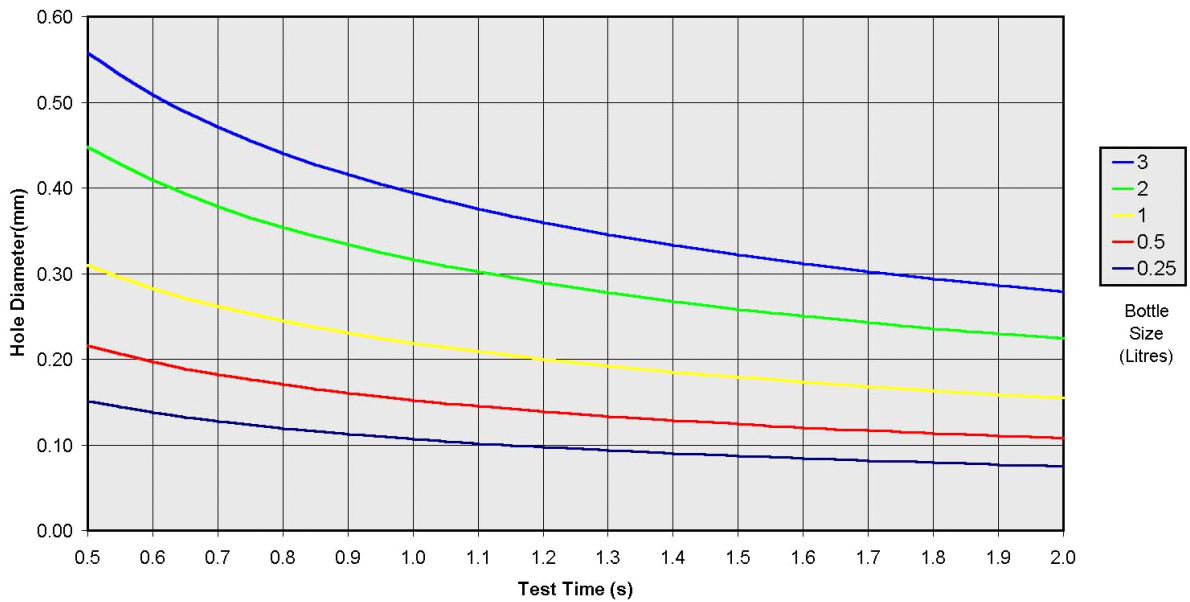
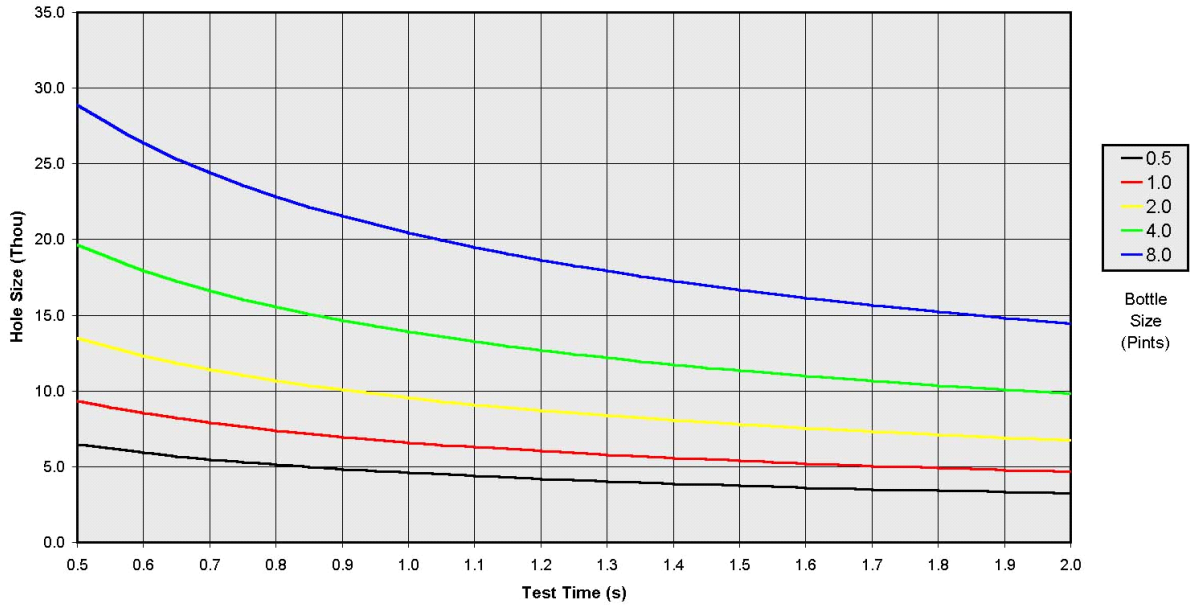

2.2 Ordering Information

The product code is specified as :

LTU200X

e.g. LTU2002

X = Number of heads = 1-3

All LTU200X units are 110VAC-only for both electrical supply and control signalling.

3 Setting Up

1. Mechanically align the test heads with the necks of the bottles. Ensure that the test heads are correctly aligned with the bottles. It is critical that a reliable seal is achieved between the bottle necks and the test head cones. The test head cylinders will generally go to end of stroke during the test. In this state, the bottles should be slightly compressed so as to achieve a good seal, but not so compressed that there is danger of collapse.
2. Press the PAGE button until the ``SETTINGS'' page is displayed.



Figure 3.1 Settings Page

3. The settings are all displayed.
4. Cycle the trimmer. Highlight the ``Test Time'' setting by touching it. Use the ``ADJ'' up and down arrows to alter the "Test Time" setting. This sets the operation time for the test head cylinders. Adjust the Test Time with the machine cycling. Observe the test head movement. Set the Test Time to the largest value possible, which does not cause bottles to be dragged out of alignment at the end of the test. It is important that the test is as long as possible. A small increase in time can make a large increase in sensitivity.

5. View the ``Max Deviation`` setting. This setting controls the sensitivity of the test. If a bottle under test deviates from a good bottle, by more than this amount, it will be rejected. The lower the value, the more sensitive. Set it to an initial value of 25%. The value can be reduced from 25% when the machine is in production and the leak tester is working consistently. Values of 1-5% are typical for normal operation.
6. View the ``Test Pressure`` setting. This sets the pressure used during the test. The pressure display bargraph is scaled to this value, to that full scale is equal to the set test pressure. A value of 30mB is typical and can be set at this time. Use lower values for large containers and higher values for small.
7. Set the external pneumatic pressure regulator FR40 to 3 bar. This sets the working pressure of the test head cylinders. It also acts as a pre-regulator to control the bottle pressurization.
8. Run bottles through the trimmer. Adjust the flow control restrictors RS1, 2,3,4 on the leak tester front panel. These control the initial bottle pressurization level. Adjust for each channel so that the pressure display bargraph goes about 2/3 of the way across the scale. This setting is not critical. If the restrictors are wound fully anti-clockwise and the pressurization level is not high enough, increase the external filter-regulator FR40 to 5 bar. The leak tester should now be testing bottles and rejecting those with holes.
9. Press the ``PAGE`` button until the ``DISPLAYS`` page is shown. The test results and bottle counts are shown. The ``Passed`` and ``Failed`` counts can be individually set to zero using the ``RESET`` button. Highlight the count by touching it then press the RESET button.

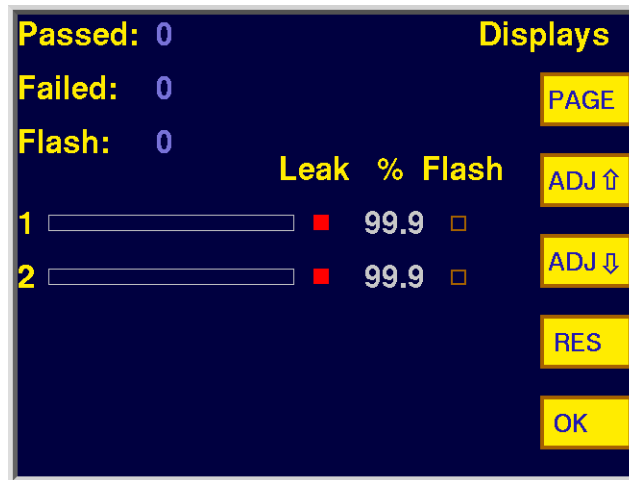

Figure 3.2 Displays Page

10. The "Leakage %" is displayed for each channel (test head). Start up bottle production and monitor the Leakage values. For each test cycle, a number is shown for each channel. The number is the percentage of the initial air pressure that has been lost, during the test. The higher the number, the higher the leakage. A value of 99.9% indicates that all of the air has escaped. Typically, the numbers will be around 5% for good bottles. This is primarily due to cooling of the air within the bottle, during the test. The numbers should be the same from cycle to cycle, within about 2% (except where a bottle is leaking). If this is so, the "Max Deviation" setting can be reduced from 25% down to a lower value, and hence improve the sensitivity of the test. The minimum value that can be used is determined by the test-to-test variation in the test results, for good bottles. This value must be established for a particular bottle type, however a value of 1% is typical. Note: Intermittent leakage around the test head will show up as larger variations in the test result.

4 Operation

The unit is fully automatic in operation. When switched off, bottle testing does not occur and the bottles are blown off the trimmer as normal. When switched on, leak testing commences with each trimmer cycle. The leak tester signals the trimmer with the results of the tests, delayed by one trimmer cycle. The trimmer controller then either blows the good bottles into the conveying system, or allows the rejected bottles to fall off the end of the trimmer.

4.1 Detailed Explanation of Operating Principle

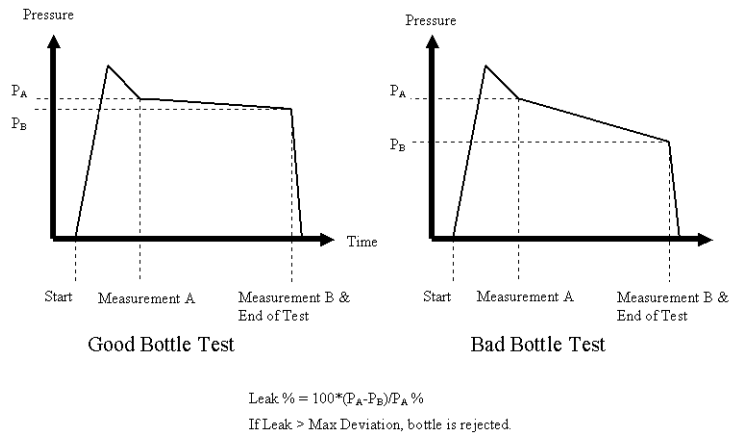

Figure 4.1 Pressure Decay Leak Detection Operating Principle

The test cycle is initiated by a signal from the trimmer. The test head cylinder valves are turned on, bringing the test heads in to seal on the bottles. At the same time, the pressurization valves are turned on, allowing the bottles to pressurize. When the pressure in a bottle rises past a threshold, the pressurization valve associated with that channel is turned off. After a short delay, the pressure in each bottle is measured (Pressure A). The bottles remain sealed for the remainder of the test time. At the end of the test, the pressures in the bottles are again measured (Pressure B). The test heads are then retracted.

The percentage of pressure decay is then calculated from the two pressure measurements. This is the result of the test.¹

The decision of pass or fail is made as follows:

For each channel, an average is maintained of the test results (leak %) for bottles that have passed the test. When a test is performed, the result is compared with this average. If the difference (deviation) is greater than the set "Max Deviation", the bottle is rejected. If the deviation is less than the maximum, then the bottle is passed and the result is incorporated into the average.

The advantage of this technique is that slow drifts over time of airline pressure, air temperature, pneumatic settings and bottle characteristics are compensated for. If a simple fixed limit was set on the amount of "leakage" (pressure drop) allowed, then the sensitivity of the system would be limited by long term variations in the test characteristics, and the channel-to-channel mismatches.

¹ There are several other checks required in order to catch exceptional conditions. For example, we reject the bottle if there is insufficient initial pressurization, or if the bottle collapses during the test, creating a pressure rise.

5 Screens

The LTU2000 touch screen display has several screen ``pages'', accessed by pressing the ``PAGE'' button.

5.1 DISPLAYS Screen

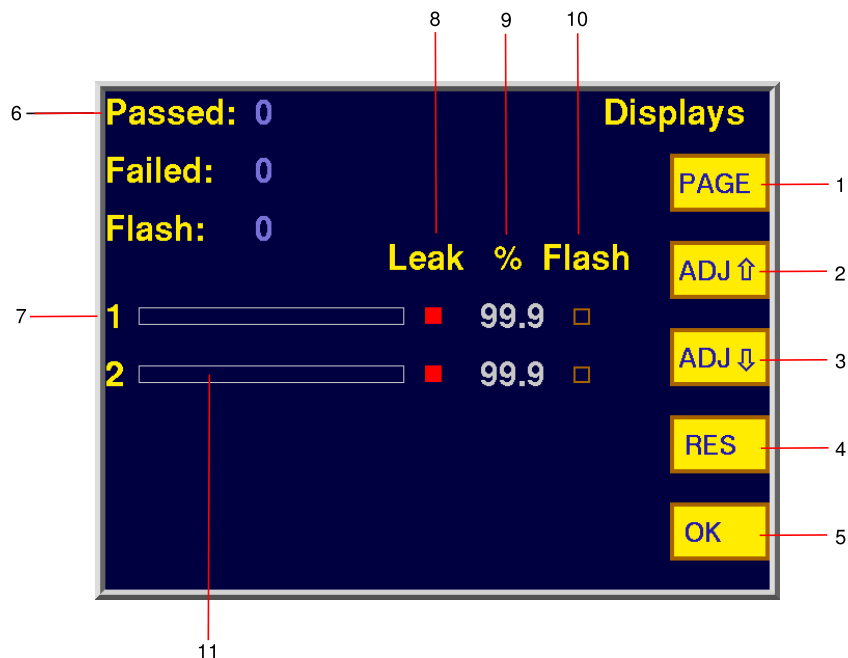

Figure 5.1 DISPLAYS Screen

1. PAGE button, cycles between the different display pages.
2. ADJ UP button, touch a setting to highlight it then press this button to increase the value of the setting.
3. ADJ DOWN as above but decreases the value
4. ``RES'' button. Touch a counter to highlight it then press this button to zero the counter. It can also be used with a setting to set it to a ``default'' value.

5. ``OK`` button. Press after changing a setting or count so as to permanently accept the change and clear the highlighting.
6. ``Passed``, ``Failed``, ``Flash`` counters. ``Passed`` is the the total count of bottles that passed all tests. ``Failed`` is the count of bottles that failed the leak test. ``Flash`` is the count of bottles that failed the optional flash / choked bore detection test.

Touch a count then press the ``RES`` button to zero the counter.

7. Channel number label. Identifies the leak detection channel. The LTU2000 can be fitted with up to 4 channels of leak detection depending on the model.
8. ``LEAK`` indicators. These are on/off indicators that turn on when the last test was a leak.
9. ``%`` - Leakage Percentage. This shows the decrease in the initial bottle pressurization measured at the end of the test. It is used to derive the test result.
10. ``Flash`` - indicator for the optional flash detection. Lit when bottle flash / choked bore is detected
11. Pressure display indicator. This provides a real-time indication of the bottle pressurization. It is useful while setting up the pneumatic pressurization rate restrictors. There is one for each leak detection channel fitted.

5.2 ``Detailed Counts`` Screen

This screen displays counters for each leak tester channel. This allows problems specific to a leak tester channel to be identified. For example if a leak test head it not sealing correctly, or if a flash detection / choked bore probe needs adjustment.

It may also identify problems associated with a particular mold depending on how the bottles are indexed vs the number of molds. (For example if mold #1 always ends up tested by channel #1).

A counter can be zeroed by touching the count, then touching the ``RES`` button.

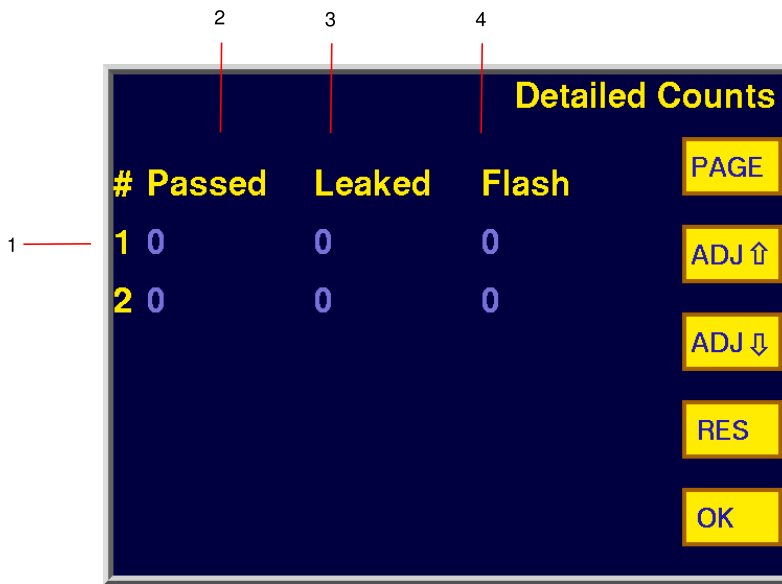

Figure 5.2 Detailed Counts Screen

1. There is a line of counts for each fitted test head / channel.
2. The ``Passed`` counter shows the number of bottles that have passed the test on that channel.
3. The ``Leaked`` counter shows the number of bottles that had leaks on that channel.
4. The ``Flash`` counter shows the number of bottles that had handle flash or a choked bore, if that option has been fitted.

5.3 SETTINGS Screen

1. ``Test Time``. This is the set ``test heads extend`` time. It should be set to be as long as is allowed by the dwell time of the trimmer.
2. ``Max Deviation``. This is essentially the leak detection threshold. A smaller value makes the test more sensitive, i.e. the LTU2000 will find smaller holes. In operation the LTU2000 self-tunes itself to the measured pressure decay of the

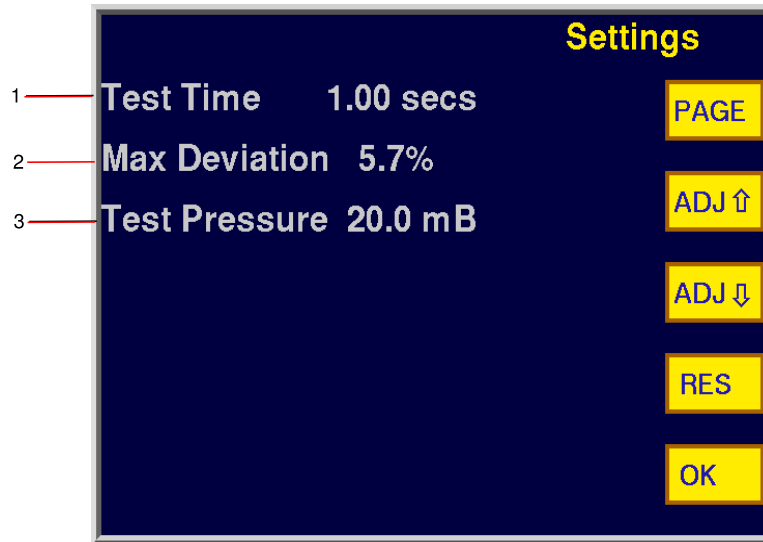

Figure 5.3 SETTINGS Screen

bottles it sees that pass the test. This setting is the maximum deviation that is allowed from this self-tuned value, before the bottle is rejected. A high default value of 25% is used to make the system easier to set up during installation. This should be reduced once everything is running and stable. Values of 3-10% are typical depending on the system.

3. ``Test Pressure''. This sets the target pressurization level at the start of the test. The default 20mB is usually suitable but this can be altered for example it can be reduced if the bottle ``balloons'' too much, or if the bottle is so large that it cannot be pressurized in the available time.

5.4 Inputs / Outputs Screen

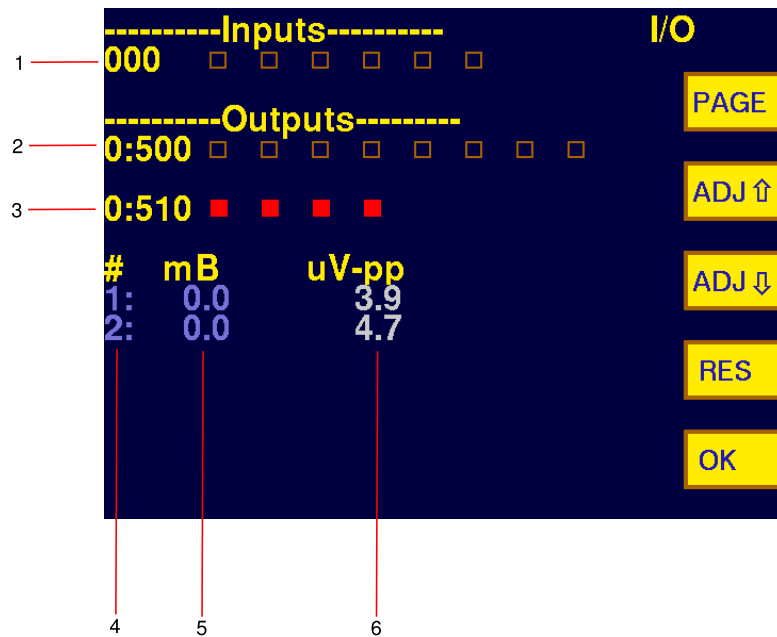

Figure 5.4 I/O Screen

This is a diagnostics screen useful during installation or fault finding. It allows the state of all the inputs and outputs of the LTU2000 to be monitored. It is also possible to force these on or off in order to test operation of valves or manually trigger a test for example.

The function of each input and output is shown in the Input / Output list chapter 7.

1. Inputs. The ``000`` labels the left hand box in the line as input #000. The next one to the right is #001 and so forth. The boxes indicate the state of the input. A filled red box is ``on`` and an empty box is ``off``.

An input can be ``forced`` on and off by touching to highlight it, then touching the ``ADJ DOWN`` button to force off, or the ``ADJ UP`` button to force on. Remove the forcing by highlighting the input then pressing ``RES`` (or turn the LTU2000 on and off).

2. Outputs 500..507. The ``500`` labels the left hand box as being output #500. The next box to the right is #501 and so forth.

3. Outputs 510..513. As above but for outputs from 510 upwards.

An output can be forced on by touching the output indicator then pressing the ``ADJ UP`` arrow to force on, or the ``ADJ DOWN`` button to force off. Touch the indicator then press ``RES`` to remove the forcing or turn the LTU2000 off and on. CAUTION take care when doing this, it is possible to damage the LTU2000 transducers by forcing on the pressurization valves with the heads down on a bottle.

4. Channel Number. Indicates the leak detection channel that is referred to by the rest of the line.
5. mB. This is the instantaneous pressure value as measured by the transducer for that channel.
6. ``uV-pp`` ``Microvolts peak to peak noise``. This is a diagnostic for the electronic circuit, it was not really ever intended for customer use! It may be removed in future revisions of the firmware.

6 Troubleshooting

In the unlikely event of a fault...

The LTU2000 series of leak testers has been designed to be extremely reliable. However we have prepared this section in case of trouble. This table has been compiled from both reported and hypothetical fault conditions. For more detailed advice and assistance please contact us directly, especially where the suggested remedy is not straightforward.

Please do not start swapping circuit boards or (especially) taking apart manifolds, unless you are sure that there is a real fault internal to the leak tester. Historically this is unlikely.

6.1 Faults Causing Good Bottles to be Rejected

<i>Symptom</i>	<i>Fault & - Remedy</i>
``Fail`` indicators illuminated	Worn test head seals - <i>Replace</i> Test head alignment incorrect - <i>Align</i> ``Max Deviation`` setting too low - <i>Adjust setting.</i> <i>Normal range is 0.5 to 2.0%. If you have to set it outside this range this indicates a problem with test head sealing or some other fault. Start off with a high setting, for example 20%. Check the test results (the displayed deviation values) are consistent from test to test. If so, reduce the set Max Deviation down until it is just above the maximum observed deviation for good bottles.</i>
``Fail`` indicators illuminated, Bottles are loose under test head.	Insufficient Sealing Force - <i>Move test head forward.</i>
``Fail`` indicators illuminated, Bottles collapse or deform during test.	Excessive sealing force - <i>Move test head back.</i>

<p>Difficulty adjusting pressurization flow controls. Over pressurization of one channel when bottle missing from another channel.</p>	<p>Pressurization pipes swapped between channels - <i>Systematically establish the correct piping by forcing each I/O in turn and checking for correct operation. (Refer to the manual for the I/O list). WARNING: do not force on the pressurization valves with the test head down on a bottle; the transducer may be damaged.</i></p>
<p>``Fail`` indicators illuminated & Warning displayed</p>	<p>Over-pressurization Pressurization flow control restrictor set too fast - <i>Turn clockwise.</i></p>
<p>``Fail`` indicator illuminated only on one channel of a multi channel machine.</p>	<p>Worn test head seals Test head alignment Excessive sealing force - <i>Move test head back.</i> Internal leakage inside leak tester - <i>Establish this by connecting a temporary short length of pipe to the pressurization outlet and blowing down it (with the unit switched off). The leak tester should not allow airflow into it. Repeat for each pressurization outlet and each transducer sense fitting. If there is a leak, check manifold fittings, valve gasket, and the internal manifold blanking plugs. Check manifold segments aligned correctly. Manifold possibly split apart at pressurization valve OR Missing / leaking manifold internal blanking plug between pressurization valve and test head valves. (Modular manifold systems only!)</i></p>
<p>Unit indicates test passed but Bottle(s) not being blown off</p>	<p>Test Time set too low - <i>Bottle blow-off is disabled by design outside of the test cycle. Make sure the test time has been set as long as possible, and that the leak tester gets its start signal as early as possible. Sometimes an external timer on the trimmer sets the reject timing, (to get a staggered blow off). Make sure that it is set to blow off the bottle within the test cycle.</i></p>
<p>One channel falsely indicates leakage (fails to pressurize), only when other channel is empty or has very large leak.</p>	<p>Leaking or missing blanking plug inside manifold, between 2 pressurization valves - <i>Replace blanking plug.</i></p>

6.2 Faults Causing Poor Sensitivity

<i>Symptom</i>	<i>Fault & - Remedy</i>
Bottles with large holes rejected correctly, very small holes passed.	Pressurization flow control restrictor set too slow - - <i>Adjust (Turn anticlockwise). Aim to get about 2/3 pressurization on the bar graphs. If this is not possible, leave at maximum and start increasing the system pressure regulator to a maximum of 4 bar. If still not possible, start reducing the set test pressure down to a minimum of 10mB.</i> "Test Time" setting too low - <i>Adjust setting as high as possible.</i> "Max Deviation" setting too high - <i>Reduce (see setting up guide).</i>

6.3 Faults Causing Blank Display & No Response

<i>Symptom</i>	<i>Fault & - Remedy</i>
Display backlight illuminated	Circuit board fault - <i>repair</i>
No display backlight	Check unit switched on and has power. Check circuit board fuses Check circuit board power connector.

6.4 Faults Causing Intermittent Valve Operation

<i>Symptom</i>	<i>Fault & - Remedy</i>
Intermittent valve operation	Faulty valve connector - <i>Replace or repair connector</i>

7 Input / Output List

This list is the same for single, twin, triple and quad models. Unused functions are simply not connected.

<i>IO</i>	<i>Function</i>	<i>Description</i>	<i>Comment</i>
0000	70	Cycle Start	Input, isolated, 24-110V, AC/DC
0500	1	Pressurization Leak Test Channel 1	Output, NPN, 24VDC
0501	2	Pressurization Leak Test Channel 2	Output, NPN, 24VDC
0504	10	Test Head 1 Extend	Output, NPN, 24VDC
0505	53	Test Head 2 Extend	Output, NPN, 24VDC
0510	54	Reject Channel 1	Output, Voltage Free Contact
0511	55	Reject Channel 2	Output, Voltage Free Contact

Table 7.1 Input / Output List

8 Electrical Installation

Please refer to the external wiring diagram on page 33 and the notes below.

The LTU2000 is an upgrade designed to be simply plugged into the existing 10-way connector. That is all that should be required electrically.

Important:

- The leak tester runs from 110VAC. Hazardous voltages are present inside the control cabinet.
- The Leak Tester *must* be earthed! The other end of the screened input cable should be securely connected to an earth point within the trimmer control cabinet.

1 AC Start Signal

A “start signal” is required that comes on at the point in the machine cycle where the bottles come to a halt at the test station. The signal is usually obtained from a platen limit switch or cam switch on the trimmer. It is extremely important that the start signal occurs immediately, so that the bottles are not waiting to be tested. This may require adjustment of the source of the signal.

The start signal should be connected so that 110VAC is put across the brown and blue wires, when the bottles come to a halt on the trimmer.

2 AC Reject

The reject signals are connected to normally closed relays inside the leak tester. When the leak tester is switched off, these are closed. The signals to the trimmer bottle blow-off valves are wired through these relays, so that the relays can interrupt

the blow-off valves and cause the bottles to fall off of the end of the trimmer. In effect, the wire from the blow-off valve is cut during installation and fed through the leak tester. The leak tester can then link the two ends together when the bottle passes the test, allowing the trimmer to blow the bottle up the takeout chute.

8.1 Signals

Refer to Figure 12.1 for the external wiring diagram.

Colors referred to are those in the pre-existing external cable.

<i>Connection</i>	<i>Wire Color</i>	<i>Comment</i>
Earth	Green + Shield	Connect securely to earth point
110V AC supply	Orange, Grey	
Blow Off channel 1	Red, Violet	
Blow Off channel 2	Yellow, White	
Start Signal AC	Brown, Blue	

Table 8.1 Basic Signals

9 Firmware Updates

The LTU2000 has a straightforward firmware update process. This can be used to update the software to add new features, fix bugs or change the basic configuration of the machine.

The firmware update process works by emulating a standard USB memory ``stick'', i.e. a flash drive. To update the firmware you will need a laptop or desktop PC, the new firmware file and a standard USB A:B cable (such as a printer cable). No special drivers are required.

Basically, the leak tester circuit board appears as a new drive letter when plugged in to a computer. It will contain a single file which is the leak tester software. To replace, simply delete this file and replace with the new one.

- *The firmware update process is done with the leak tester switched off*
- Either take a portable computer to the leak tester, or remove the circuit board assembly from the leak tester and take it to the computer.
- Connect the leak tester board to the computer using the USB cable. Note: Leak tester must be switched off. No separate power source is required; the board takes power via the USB cable.
- The leak tester board will be detected as a flash drive.
- The existing firmware will appear on this drive as a file. This file can be moved to a safe location in case you need to restore it later, or just deleted.
- Delete the existing file on the flash drive.
- Copy the new firmware file to the flash drive.
- You should see a light on the board turn red then green. This indicates the new file has been written.
- Unplug the USB cable and refit the circuit board / turn on the leak tester.

10 Battery

The LTU2000 has a lithium coin cell on the circuit board.

It is used to power the memory that stores the on-screen counts. It also currently holds the touch-screen calibration points² It is not required to maintain the main machine settings or to operate as a leak tester.

The battery has a life of about 2 years unpowered.

If the battery becomes exhausted then the count values will be lost and also, currently, the touch screen will not respond to a touch.

If this happens then the battery needs to be replaced.

The type is ``CR2032 lithium coin cell``.

It is a very common size that should be available in most electronics stores etc. Of course we can supply replacements too.

After the new battery is fitted the counts can be reset and the touch screen recalibrated as per page 31

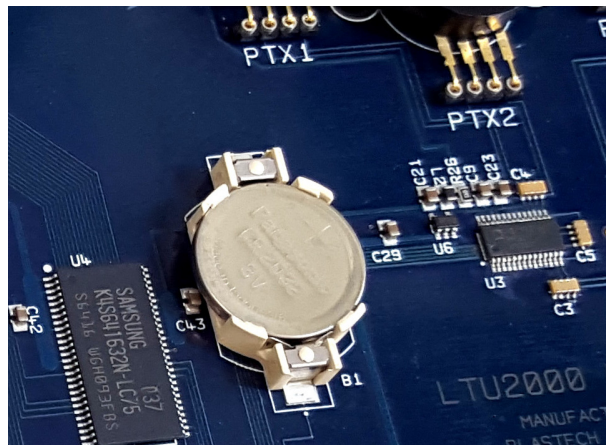

Figure 10.1 CR2032 Lithium Coin Cell

² although this may change in the future

The LTU2000 can be used for leak detection indefinitely even with a low battery. However the counts will not be retained after a power-off and the touch screen will not respond.

11 Touch Screen Calibration

If the touch screen does not respond correctly to touch then it probably needs to be recalibrated. This can happen if the battery is flat or possibly after the firmware is updated.

To recalibrate:

- switch off
- switch on while touching the middle of the screen
- the screen should prompt to touch a corner, then touch the opposite corner. Proceed as directed.
- the screen should work now. If not there is a fault.

If the same thing happens each time the LTU2000 loses power then the battery is low. Replace the battery as per page 29.

12 Drawings

The system shown in the following drawings is a 4-channel system. Single, twin and triple channel follow the same general layout; the parts for the extra channels are simply omitted.

Figure 12.1 LTU2000 External Wiring Diagram

IMPORTANT: EQUIPMENT MUST BE EARTHED

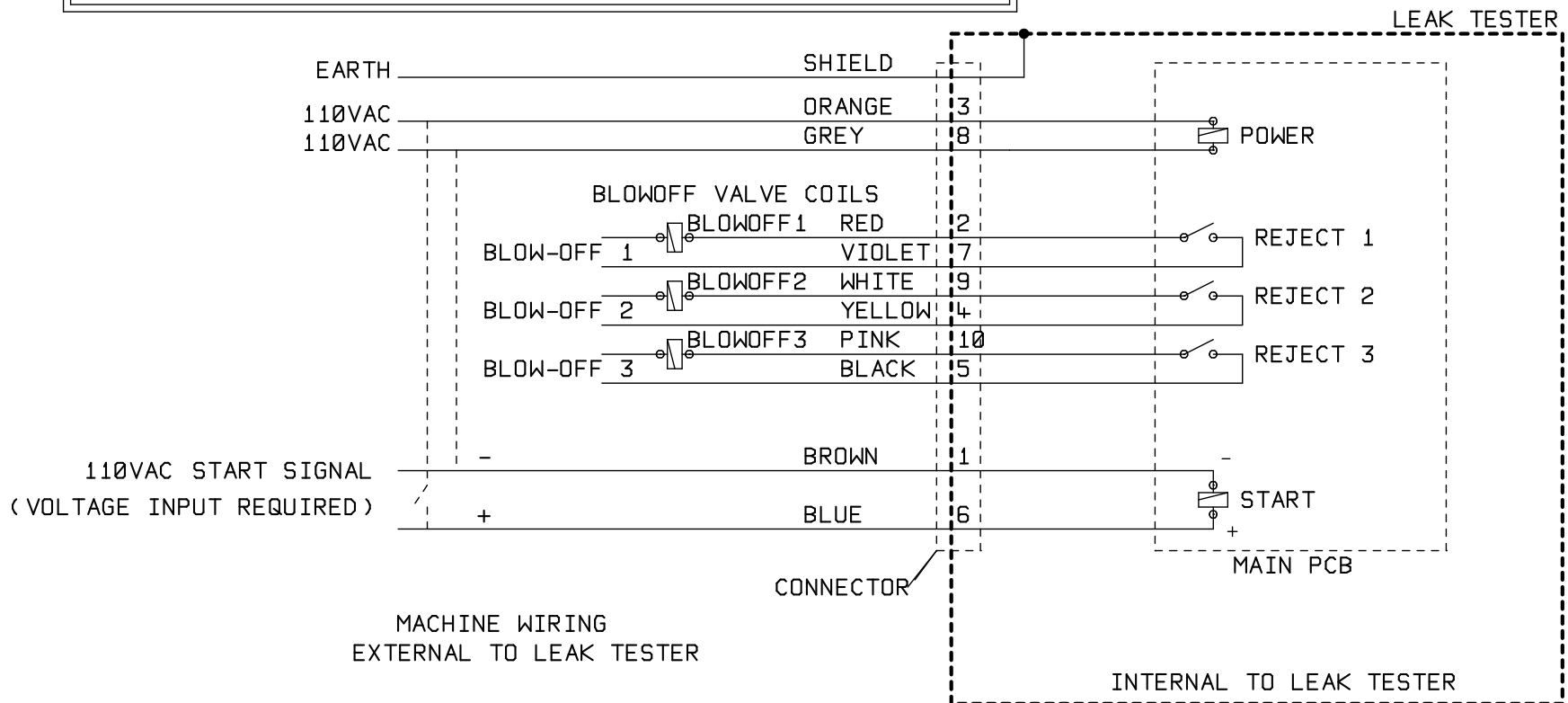

Figure 12.2 LTU2000 Control Cabinet Internal Wiring

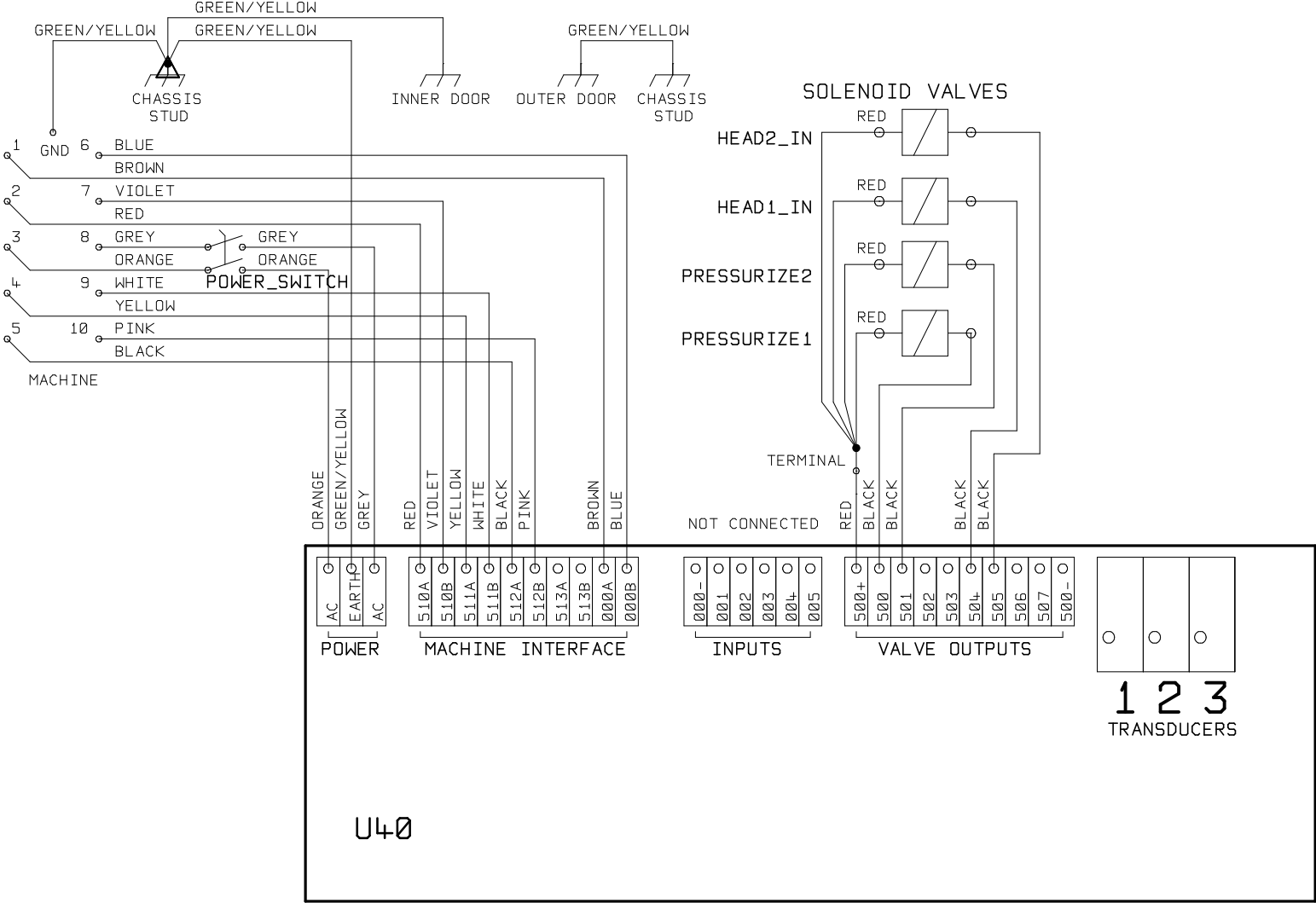

Figure 12.3 LTU2000 Control Cabinet Layout

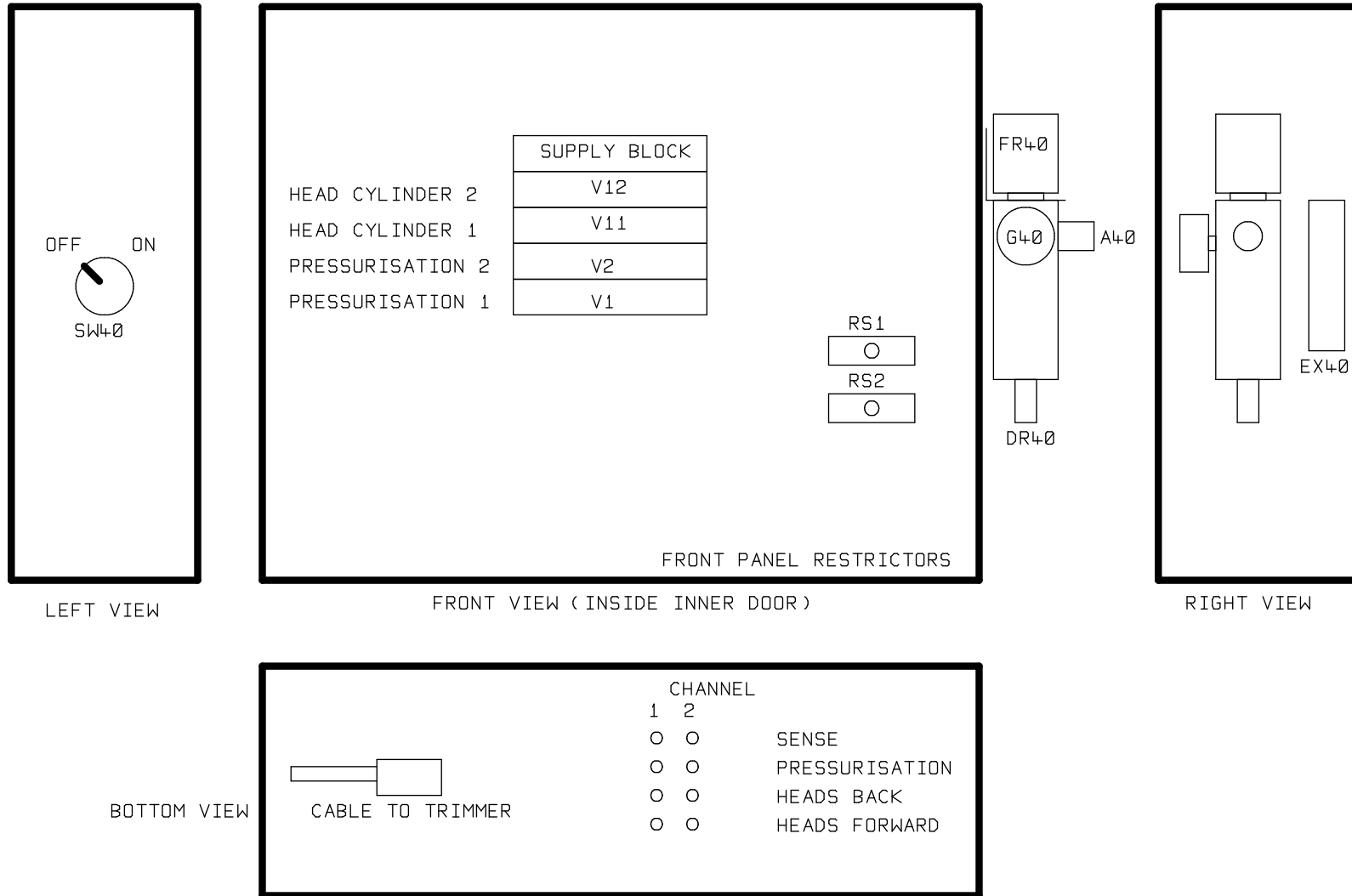
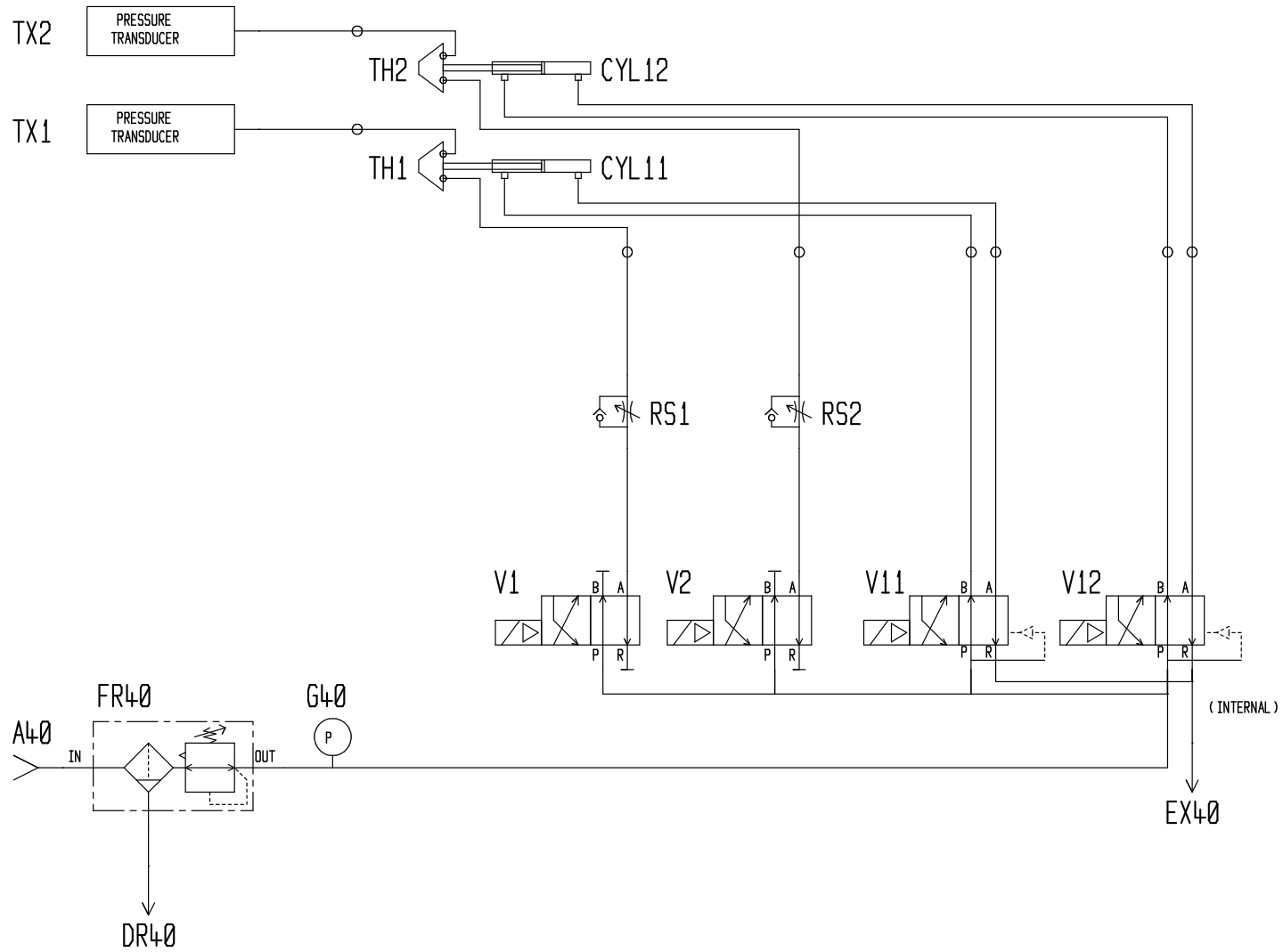

Figure 12.4 LTU2000 Control Cabinet Pneumatics



13 Spares

<i>Part ID</i>	<i>Description</i>	<i>Ref</i>	<i>Function</i>
1019	Filter Regulator, auto drain, 3/8 ported	FR40	Air In
62	Pressure Gauge, screw in, 1/8 ported, 0-10 Bar	G40	System Pressure
598	Restrictor, Panel Mount, 1/8	RS1-4	Pressurization Rate Control
783	Valve, 5-2, Common Pilot	V11-14	Test Head Cylinder Valves
812	Valve, 5-2, Independent Pilot	V1-4	Pressurization Valves
196101	PCB + Touch Panel Assembly	U40	
1586	Battery, CR2032	B1	Memory Backup Battery
195201	PCB-LTU2000	PCB	Circuit Board

13.1 Notes on Spares

The "Part ID" column shows the internal Plastech Controls stock number for the part. This can be used for ordering purposes.

The LTU2000 uses the same circuit board for all leak tester configurations. A board from a twin channel unit can be used in a single channel machine.

Produced by Plastech Control Systems Ltd

Revision 21

As a policy of continual improvement, Plastech Control Systems Ltd reserve the right to alter specifications without prior notice.

Except as permitted by such licence, no part of this publication may be reproduced, stored in retrieval system or transmitted, in any form or any means, electronic, mechanical, recording, or otherwise, without prior written permission of Plastech Control Systems Ltd.

Plastech Control Systems Ltd
Unit 10 Ketterer Court
Jackson Street
St Helens
Merseyside UK
WA9 3AH

Tel: +44 (0)1744 734 123
Fax: +44 (0)1744 734 340
USA Number 414 426 8843
Email: sales@plastech-controls.com
Website: www.plastech-controls.com

www.plastech-controls.com